

**CASHFLOW™ 7000 Series
Change giver**

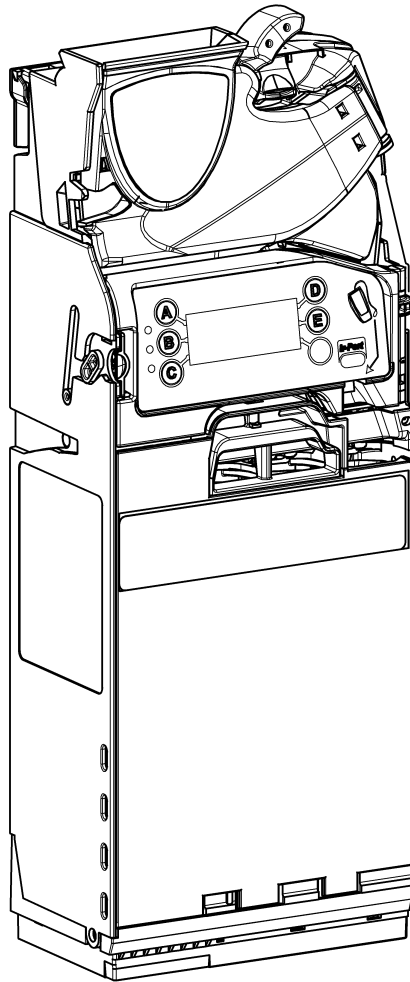

START- UP GUIDE



**GB
FR
DE
ES
IT**

INSTALLATION

Preparing for Installation

- ◆ Turn OFF all power to the vending machine.

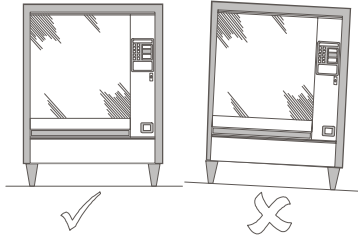

- ◆ To ensure that the changegiver performance is not affected, visually check the vending machine is upright, both from the front and side.
- ◆ Before mounting the changegiver to the vending machine, check the operating voltage of the vending machine matches that stated on the changegiver label.

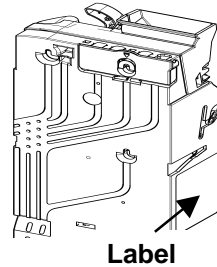

Installing the changegiver to the machine

The changegiver is mounted onto the vending machine by hanging it onto three studs located on the vending machine. To do this you will need to open the discriminator assembly and line up the mounting keyholes of the coin manager with the vending machine studs.

- ◆ Press the yellow button at the top of the coin manager and gently lift and pull the discriminator assembly forward. Once open, the mounting keyholes will be made visible.

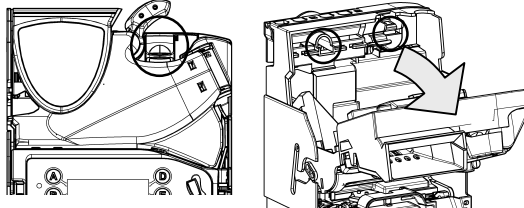

- ◆ To securely fix the changegiver in place, partly unscrew the three machine studs.
- ◆ Line up the three mounting keyholes of the changegiver with the studs and hang it in place ensuring that the changegiver is sitting flat against the machine back plate.

- ◆ Tighten all three studs and return the discriminator back to its normal position.

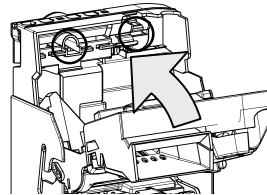
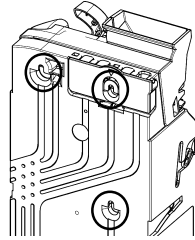

Alignment Checks

Once the changeover has been securely fitted to the vending machine, check reject lever operation and coin chute alignment. Do this without any power applied to the machine.

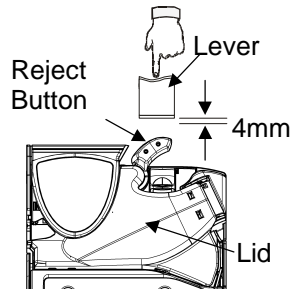

Check there is a minimum 4mm gap between the machines reject lever mechanism and the changeover reject button. Press the machine lever a couple of times and ensure the lid of the discriminator opens and closes correctly.

Check machine coin chute alignment by inserting two of each coin denomination through the coin entry slot of the machine. Ensure that the inserted coins fall freely into the changeover and exit out into the machines cash return cup.

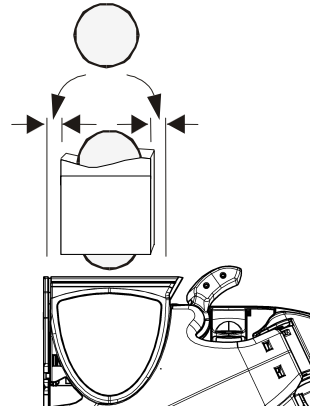

Cable Connection

The changeover may be fitted with more than one cable, these may be intended for TX-RX communications, drive an external display or to extract audit data.

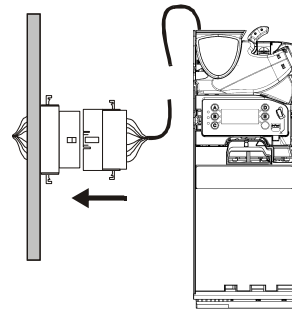

Once all relevant cables are connected and before closing the machine door, tuck any unused cables away tidily ensuring that none are trapped between the reject lever mechanism and the vending machine door. You can now switch ON the power to the vending machine.

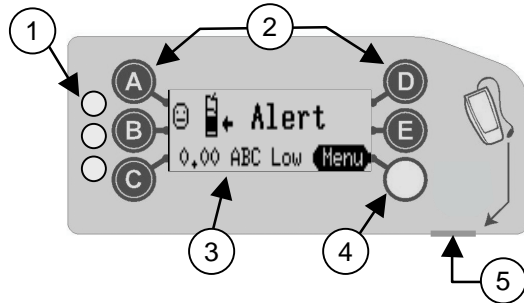

KEYPAD FUNCTIONS

On the front of the CashFlow® 7000 change giver there is a user interface keypad. The keypad has three LEDs, six function buttons, large menu display and depending on the change giver model, an infrared port. This keypad allows you to dispense coins from the five-tube dispenser, access & navigate through the configuration menus and monitor the status of the change giver.



1	3 LEDs	Red, Amber, Green
2	 to 	Dispense coins & navigate through menus
3	Display (LCD)	Menu information & warning display
4	 Mode Button	Access service & set-up menus
5	Service Connector	CPM Compatible

The LEDs provide a visual indication by light flashes that report the state of the change giver. An LED can either be ON, OFF or FLASHING. These light flash codes can indicate when the change giver is operating normally, is in configuration/program mode or has a fault. (Refer to the LED light code section for more information).

The blue keys (marked A to E) have two functions.

When the change giver is in idle mode, pressing a blue button on its own will dispense a coin from that tube. When you press and hold the blue button for approx. 4 seconds, this activates auto dispense (latch dispensing of coins) until the tube is empty of coins. If however, the yellow (mode) button is pressed, the blue buttons are then used for navigation through the change giver **service** and **set-up mode** menus. (Refer to menu structure section).

Service Mode: gives access to the most frequently used product configuration options. (See Service Mode Options)

Set-up Mode: gives access to general product configuration options that are required when setting up your change giver. (See Set-up Mode Options)

GETTING STARTED

At first power up, the changegiver will run a self test, where the changegiver motor will sound, the LEDs will cycle five times through a sequence of red, amber & green and briefly display its software revision.

As there are no coins in the tube cassette, the display will show a “**Tubes Low**” message requesting that the coin tubes be filled to a predefined level (refer to the floating coin tubes section). Once the changegiver has enough coins in the tubes, message will display the coin totals (in currency value) stored in the tubes.

Note: MEI recommends that a small number of coins (e.g. 5 of each) be inserted in each tube prior to leaving the machine.

Floating the Coin Tubes

There are two ways to float the changegiver tubes with coins. You can: 1) manually fill each tube by inserting coins into the tubes or 2) access the service mode and select “Float” then insert each coin through the discriminator.

Filling Tubes Manually

1. Remove the tube cassette from the changegiver
2. Insert required number of coins in to relevant storage tubes
3. Re-fit tube cassette back on to the changegiver.

The changegiver will now begin an automatic tube calibration measurement were a clicking sound will be heard, this is normal. Once calibration is complete, the display will show a total currency value of the coins inserted. If a tube is left empty the display will show a tube low message for the particular tube.

Fill Tube using the Service Mode Menu

1. Press the Yellow Mode button once
2. Press button A and start inserting coins through the discriminator
3. The display will show the number of coins that are required for each tube. (each time a coin is inserted the displayed count will decrement by one)
4. Press button A to exit float mode

Changegiver Menu Structure

Service Mode

There are two ways to access the Set Up menus.

1. Press and hold the mode button for 2 seconds
2. Press the mode button once and select the “Setup” option by pressing button E. (This method requires a pass code. When asked for this, press buttons ABC)

Press button D - Scrolls UP the menus



Press button E - Scrolls DOWN the menus

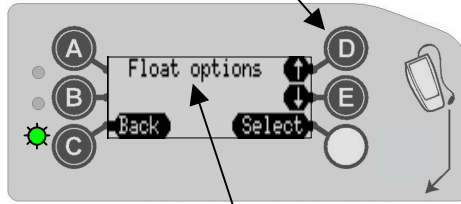

Menu Option Selected

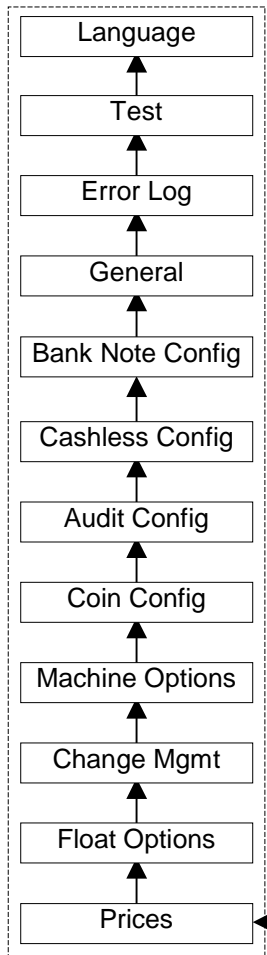































EXAMPLE: - How to set the language









1. Press the mode button once
2. Press button **E** to select **setup**
3. Enter pass code, Press **ABC**
4. Press button **D** to scroll up the menu until the display shows **Language**
5. Press **Select** then **Edit**
6. Use button **D** or **E** to scroll to the required language
7. Select **OK**
8. Select **Back** and **Back** again to save and exit your setting

Service Mode Options (Quick Menu Codes)

This list shows the most commonly used service modes.







Press Following Button Sequence	Description / Action
 	Float coin tubes / (Insert coins then press Mode button)
  	Clear accumulated credit and clear "clean me" message. This feature is not available on an MDB product.
  	Float Teach sets float levels to current coin tube levels.
 	Inhibit a coin / (Insert a coin and then press the reject lever)
 	Enable a coin / (Insert a coin and then press Mode button)
  	View coin details / (press  to scroll up) (press  to scroll down)
  	View channel set / (press  to exit view)
 	Teach vend price / (Insert coins to the value of the price and then press the price line button on the machine to set it) (When finished press the  button) This feature is only available on Executive products.
 	Custom tube cassette teach / (Enter coins then press )
   	Select predefined tube cassette / (enter code on cassette label & press mode button)

General LED Light Codes

	On - Change giver OK.
	Cycles x 5 - Normal power up sequence. Change giver OK.
	Blinks Off - Coin accepted / rejected.
	Flashing - Change giver in Menu mode
	On – Change giver inhibited by VMC.
	Flashing - Change giver requires attention. (Refer to Amber LED light codes)
	Off - No Power to Change giver. (Check power looms are connected & ensure power is switched ON)
	Alternating - Change giver Faulty (Remove from vending machine)

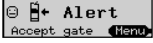
Amber LED Light Codes

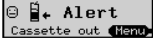
If the amber LED flashes, this indicates that a fault has been detected on one of the change giver main modules. These types of fault can be rectified at the machine and can be for example caused by; a coin jam; dirt built up; or the cassette has been removed etc. The change giver will also indicate the module affected on its display.

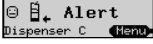
Flashes	Check Change giver Module	
1 x 	Discriminator	
2 x 	Accept gate	
3 x 	Separator module	
4 x 	Dispenser module	

Selecting Predefined Cassette

The change giver has stored in memory, a selection of predefined tube cassettes that provide different payout options. (See table below).

By pressing the correct buttons codes on the keypad, you can select the required payout option.

The correct button sequence code can also be found on the front label of the cassette.

To select a predefined cassette, Press the Mode button then D followed by the button code.

Finally select accept from the menu to confirm and save.

Button Code	Tube A	Tube B	Tube C	Tube D	Tube E
AA	5c	10c	50c	20c	5c
AB	1c	10c	50c	2c	5c
AC	5c	10c	50c	20c	1€uro
AD	5c	10c	50c	10c	1€uro
AE	5c	10c	50c	10c	5c
BA	10c	10c	50c	10c	1€uro
BB	10c	10c	50c	20c	1€uro
BC	20c	10c	50c	1€uro	2€uro
BD	1€uro	-	50c	1€uro	2€uro
BE	1€uro	-	50c	2€uro	2€uro
CA	1c	10c	50c	1€uro	5c

SAFETY

National & International Standards Conformance

CashFlow® 7000 Series products operate at Safety Extra Low Voltage Level (SELV) as defined in IEC335/EN60335 'Safety of Household and Similar Appliances'. They may be designed into equipment complying with IEC335/EN60335 or IEC950/EN60950 'Safety of Information Technology Equipment'.

CashFlow® 7000 Series products are of Class 3 construction.

Rated Operating Voltage

The operating voltage of a CashFlow® 7000 Series Change giver is stated on the label attached to the product. It must not be used with any power source other than that indicated.

Dangerous Environments

The CashFlow® 7000 Series Change giver must not be operated in the presence of flammable gasses, fumes or water.

Product Disposal

Do not dispose of any part of a CashFlow® 7000 Series Change giver by incineration.

CashFlow® 7000 Series Change giver Start-Up Guide

Revision G1

Publication Date: November 2003



Published by:

MEI

Eskdale Road

Winnersh Triangle

Wokingham, Berkshire

RG41 5AQ

United Kingdom

Internet: <http://www.meiglobal.com>

For a copy of the Engineers Handbook, please write to the Technical Service Manager at the above address.

Mars®, CashFlow® and the MEI device are registered trademarks. Copyright Mars Inc 2003.

**Monnayeur
CASHFLOW™ 7000**

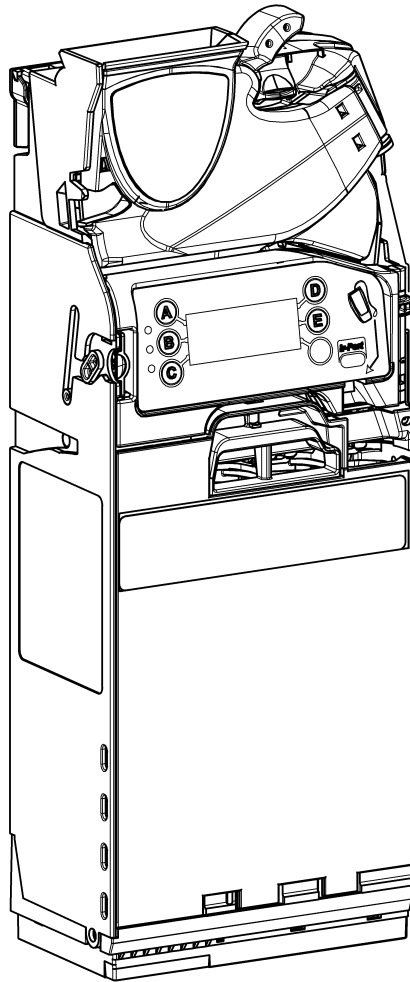

GUIDE D'INITIATION RAPIDE



FR

INSTALLATION

Préparation à l'installation

- ◆ Coupez toute alimentation électrique au distributeur.

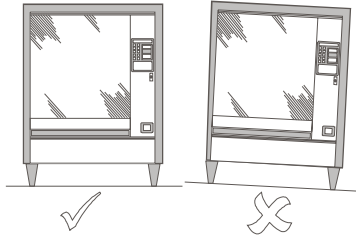

- ◆ Vérifiez que la performance du monnayeur n'est pas affectée : le distributeur doit être parfaitement droit, à la fois de face et de profil.
- ◆ Avant de monter le monnayeur dans le distributeur, vérifiez que la tension d'exploitation du distributeur correspond à celle qui est indiquée sur l'étiquette du monnayeur.

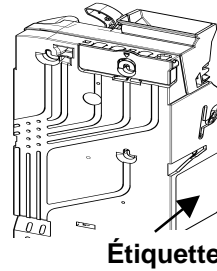

Installation du monnayeur dans la machine

Le monnayeur se pose dans le distributeur en l'accrochant à trois goujons situés sur le distributeur. Pour accrocher le monnayeur, commencez par ouvrir le discriminateur, puis alignez les alésages du monnayeur sur les goujons de fixation dans le distributeur.

- ◆ Appuyez sur le bouton jaune en haut du monnayeur et soulevez doucement le discriminateur en le tirant vers vous. Lorsqu'il est ouvert, les alésages sont visibles.

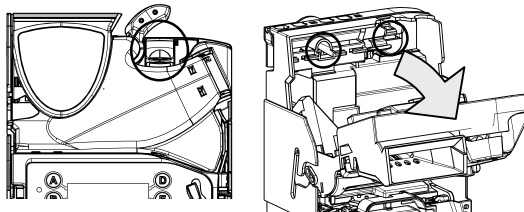

- ◆ Pour fixer le monnayeur, dévissez partiellement les goujons de fixation dans la machine.
- ◆ Alignez les trois alésages du monnayeur sur les goujons et accrochez l'appareil, en prenant soin de le poser à plat contre la plaque dorsale de la machine.

- ◆ Resserrez les trois goujons et remettez le discriminateur dans sa position normale.

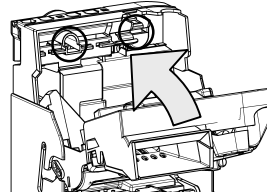
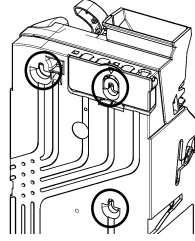

Vérification de l'alignement

Une fois le monnayeur fixé au distributeur, vérifiez le fonctionnement du levier de remboursement et l'alignement de la goulotte de descente de pièces. Pendant cette opération, la machine ne doit recevoir aucune alimentation électrique.

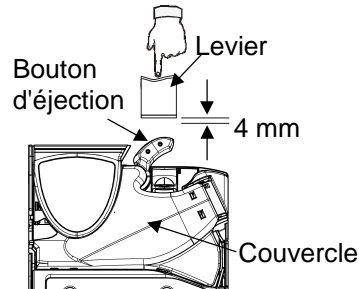

Vérifiez qu'un écart de 4 mm existe entre le levier de remboursement et le bouton d'éjection du monnayeur.

Actionnez le levier deux fois, et vérifiez que le couvercle de discriminateur s'ouvre et se ferme correctement.

Vérifiez l'alignement du rendu de monnaie en insérant une pièce de chaque type dans la fente de la machine. Vérifiez que les pièces insérées tombent librement dans le monnayeur et ressortent par la sébile de remboursement du distributeur.

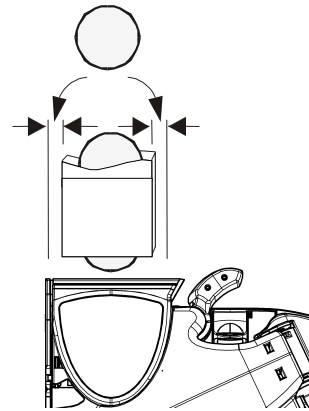

Connexion des câbles

Le monnayeur peut être équipé de plusieurs câbles, pouvant servir aux communications de transmission et de réception, à l'alimentation d'un écran externe ou à l'extraction des données d'audit.

Une fois tous les câbles appropriés connectés, et avant de refermer la porte de la machine, rangez les câbles non utilisés en vérifiant qu'ils ne sont pas coincés entre le levier de remboursement et la porte du distributeur. À présent, vous pouvez remettre le distributeur sous tension.

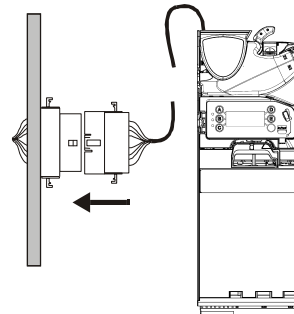

FONCTIONS DU CLAVIER

L'avant du monnayeur CashFlow® 7000 présente un clavier d'interface. Ce clavier comporte trois voyants, six touches de fonction, un grand écran et, en fonction du modèle, un port infrarouge.

Ce clavier vous permet d'éjecter les pièces de la cassette à cinq tubes, d'accéder aux menus de configuration et de les parcourir, et de surveiller l'état du monnayeur .

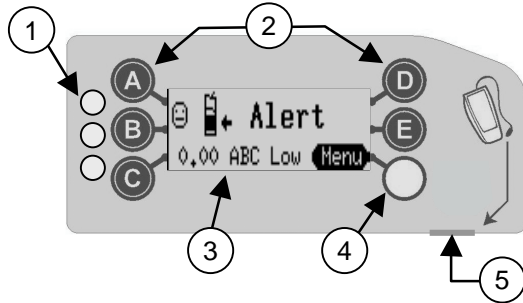

1	3 voyants	Rouge, orange, vert
2	A à E	Éjecter les pièces et parcourir les menus
3	Écran à cristaux liquides	Informations des menus et avertissements
4	Touche Mode	Accéder aux menus de configuration et de maintenance
5	Connecteur de maintenance	Compatible avec le CPM

Les voyants clignotent pour donner les indications d'état du monnayeur. Un voyant peut être allumé, éteint ou clignotant. Les codes de clignotement indiquent que le monnayeur fonctionne normalement, en mode de configuration ou de programmation, ou est défaillant. (Consultez la section « Codes des voyants » pour de plus amples informations.)

Les touches bleues (A à E) ont deux fonctions.

Lorsque le monnayeur est en mode inactif, le fait d'appuyer sur une touche bleue éjecte une pièce du tube correspondant. Lorsque vous maintenez une touche bleue enfoncée pendant environ 4 secondes, l'autoéjection (éjection forcée de toutes les pièces) est activée, jusqu'à ce que le tube correspondant soit vide. Si toutefois, la touche jaune (Mode) est actionnée, les touches bleues servent uniquement à la navigation dans les menus de **maintenance** et de **configuration** du monnayeur. (Voir la section « Structure des menus ».)

Mode maintenance : donne accès aux options de configuration de produit les plus fréquemment utilisées. (Voir Options du mode maintenance)

Mode configuration : donne accès aux options générales de configuration du produit nécessaires pour configurer le monnayeur. (Voir Options du mode configuration)

DÉMARRAGE

À la première mise sous tension, le monnayeur effectue son autodiagnostic : le moteur du monnayeur tourne, les voyants s'allument cinq fois en rouge, orange et vert, et l'appareil affiche brièvement sa version logicielle.

La cassette de tubes étant vide, l'écran affiche une alerte de bas niveau de remplissage, et le système vous demande de remplir les tubes à un niveau prédéterminé (voir la section « Remplissage des tubes de pièces »). Lorsque les tubes contiennent suffisamment de pièces, le message affiche le total de la valeur des tubes, dans la devise sélectionnée.

Remarque : MEI recommande d'insérer un petit nombre de pièces (5 de chaque) dans chaque tube avant de quitter la machine.

Remplissage des tubes de pièces

Vous pouvez remplir les tubes de pièces de deux manières. Vous pouvez : 1) remplir chaque tube manuellement en insérant les pièces ; 2) accéder au mode de maintenance de l'appareil, sélectionner l'option Remplissage, et insérer chaque pièce par le discriminateur.

Remplissage manuel des tubes

1. Sortez la cassette du monnayeur.
2. Insérez le nombre requis de pièces dans les tubes correspondants
3. Remontez la cassette dans le monnayeur.

Le monnayeur effectue alors l'étalonnage automatique des tubes et un cliquetis se fait entendre, ce qui est normal. Une fois l'étalonnage terminé, l'écran affiche la valeur totale des pièces insérées dans la devise correspondante. Si un tube reste vide, le message d'alerte de bas niveau de tube s'affiche, pour le tube concerné.

Remplissage des tubes à l'aide du menu de mode maintenance

1. Appuyez une fois sur la touche jaune.
2. Appuyez sur la touche A et commencez à insérer les pièces dans le discriminateur.
3. L'écran affiche le nombre de pièces requises pour chaque tube. (Chaque fois qu'une pièce est insérée, le compte de pièces diminue d'un point.)
4. Appuyez sur la touche A pour quitter le mode de remplissage.

Structure des menus du monnayeur

Mode maintenance

Vous accédez aux menus de configuration de deux manières différentes.

1. Maintenez la touche de mode pendant 2 secondes.
2. Appuyez une fois sur la touche de mode et sélectionnez l'option Configuration en appuyant sur la touche E. (Cette méthode nécessite l'entrée d'un code. Lorsque le système vous le demande, appuyez sur les touches ABC)

Touche D – Défilement vers le haut



Touche E – Défilement vers le bas

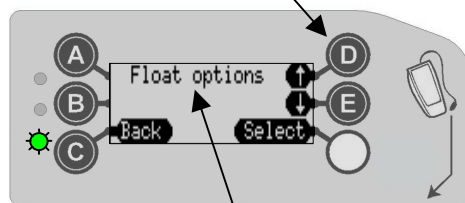

Option de menu sélectionnée

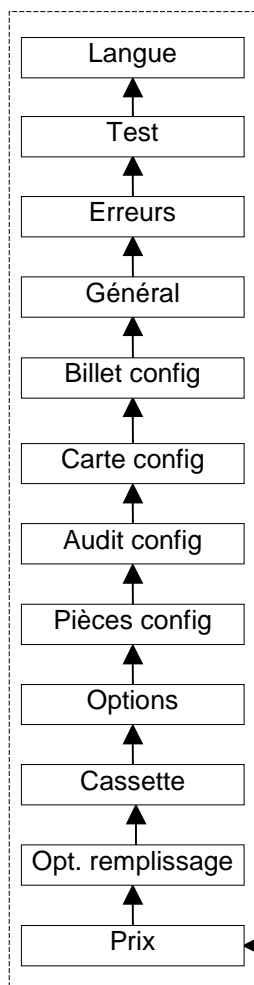































Le menu commence ici

EXEMPLE : choix de la langue







1. Appuyez une fois sur la touche Mode
2. Appuyez sur **E** et sélectionnez **Prog. Générale**
3. Entrez le code **ABC**
4. Appuyez sur **D** pour faire défiler le menu et afficher **Langue**
5. Sélectionnez **OK** puis **Editer**
6. Utilisez les touches **D** ou **E** pour faire défiler jusqu'à la langue requise
7. Sélectionnez **OK**
8. Sélectionnez **Retour** deux fois pour enregistrer votre choix

Options du mode maintenance (Codes du menu de raccourci)

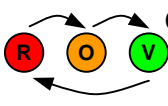
Cette liste présente les codes de maintenance le plus fréquemment utilisés.





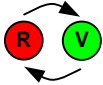



Appuyez sur les touches en séquence	Description/Action
 	Remplir les tubes de pièces / Insérez les pièces, puis appuyez sur la touche Mode
  	Effacer le crédit qui s'est accumulé et effacer le message « Nettoyage nécessaire ». Cette fonction n'est pas disponible sur le produit MDB.
  	L'apprentissage du remplissage aligne les niveaux de remplissages sur les niveaux actuels des tubes de pièces.
 	Inhiber une pièce / (Insérez une pièces, puis actionnez le levier de remboursement)
 	Activer une pièce / (Insérez une pièce puis appuyez sur la touche Mode)
  	Afficher les coordonnées de la pièce / (Appuyez sur  pour faire défiler vers le haut) (Appuyez sur  pour faire défiler vers le bas)
  	Affiche la gamme de pièces / (Appuyez sur  pour quitter cette vue)
 	Apprendre le prix de vente / (Insérez les pièces correspondant à la valeur de l'achat, et appuyez sur la touche de ligne de prix de la machine pour la configurer) (Lorsque vous avez terminé, appuyez sur la touche ) Cette fonction n'est disponible que sur les produits de la gamme Executive.
 	Apprentissage cassette personnalisée / (Insérer pièces et appuyer sur )
   	Sélectionner la cassette prédéfinie / (Entrer le code de cassette et terminer par mode)

Codes des voyants lumineux

	Fixe – Monnayeur OK.
	Cinq cycles – Séquence normale de mise sous tension. Monnayeur OK.
	Clignotement / Arrêt – Pièce acceptée / éjectée.
	Clignotement – Monnayeur en mode Menu
	Fixe – Monnayeur inhibé par la machine.
	Clignotement – Le monnayeur requiert votre attention. (Consultez les codes de voyant orange)
	Éteint – Le monnayeur n'est pas sous tension. (Vérifiez que les câbles sont correctement branchés, et que l'appareil est alimenté.)
	Mode alternatif – Le monnayeur est défaillant. (Retirez-le du distributeur.)

Codes du voyant orange

Lorsque le voyant orange clignote, il indique qu'une défaillance a été détectée sur l'un des principaux modules du monnayeur. Ce type de défaillance peut être rectifié sur la machine et peut être causé, par exemple, par une pièce bloquée, l'accumulation de poussière ou le retrait de la cassette etc. Le monnayeur indique également le module affecté.

Clignote	Vérifiez le module du monnayeur	
1 x 	Discriminateur	
2 x 	Porte d'acceptation	
3 x 	Module séparateur	
4 x 	Module d'éjection	

Sélection d'une cassette de tubes prédéfinie

Le monnayeur mémorise une sélection de cassettes de tubes prédéfinie, qui permet différentes options de rendu de monnaie. (Voir le tableau ci-dessous.)

Appuyez sur les touches appropriées en séquence au clavier, et vous pouvez sélectionner l'option de rendu de monnaie désirée.

La séquence correcte de touches se trouve également sur l'étiquette frontale de la cassette.

Pour sélectionner une cassette prédéfinie, appuyez sur la touche Mode puis sur D et enfin tapez le code.

Pour terminer, validez à l'aide du menu pour confirmer, et enregistrez votre choix.

Code	Tube A	Tube B	Tube C	Tube D	Tube E
AA	5c	10c	50c	20c	5c
AB	1c	10c	50c	2c	5c
AC	5c	10c	50c	20c	1€uro
AD	5c	10c	50c	10c	1€uro
AE	5c	10c	50c	10c	5c
BA	10c	10c	50c	10c	1€uro
BB	10c	10c	50c	20c	1€uro
BC	20c	10c	50c	1€uro	2€uro
BD	1€uro	-	50c	1€uro	2€uro
BE	1€uro	-	50c	2€uro	2€uro
CA	1c	10c	50c	1€uro	5c

SÉCURITÉ

Conformité avec les normes nationales et internationales

Les produits CashFlow® de la série 7000 fonctionnent à un niveau de basse tension de sécurité (SELV) tel que défini dans la norme IEC335/EN60335 'Safety of Household and Similar Appliances'. Ils peuvent être intégrés à des appareils conformes aux normes IEC335/EN60335 ou IEC950/EN60950 'Safety of Information Technology Equipment'.

Les produits CashFlow® de la série 7000 sont de construction Classe 3.

Tension d'alimentation

La tension d'alimentation des produits CashFlow® de la série 7000 est indiquée sur l'étiquette apposée au produit. Le monnayeur ne doit pas être utilisé avec des sources d'alimentation autres que celles qui sont indiquées.

Environnements dangereux

Ne pas utiliser le monnayeur CashFlow® de la série 7000 en présence de gaz inflammables, de fumées ou d'eau.

Mise au rebut des produits

Ne pas mettre au rebut un composant de monnayeur CashFlow® de la série 7000 par incinération.

Monnayeur CashFlow® 7000 Guide d'initiation rapide

Révision G1

Date de publication : November 2003



Publié par :

MEI

Eskdale Road

Winnersh Triangle

Wokingham, Berkshire

RG41 5AQ

Royaume-Uni

Internet : <http://www.meiglobal.com>

Pour obtenir le manuel de maintenance de cet appareil, veuillez écrire au directeur technique (Technical Service Manager) à l'adresse ci-dessus.

Mars®, CashFlow® and the MEI device are registered trademarks. Copyright Mars Inc 2003.

**Münzwechsler der Serie
CASHFLOW™ 7000**

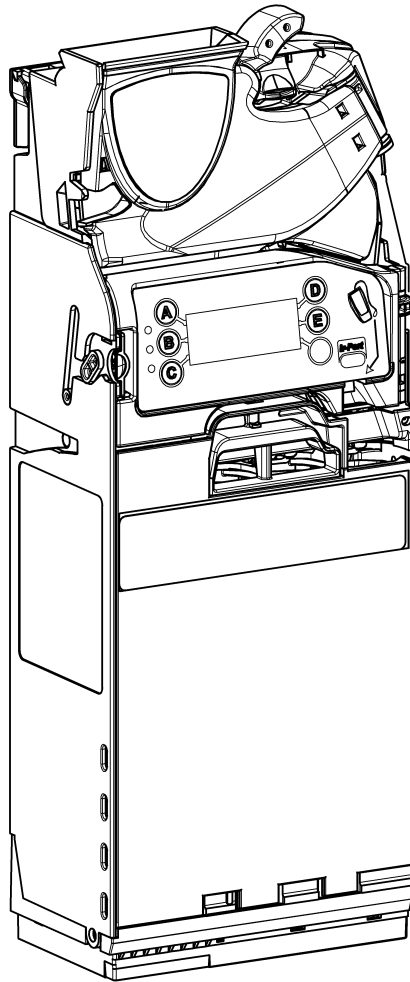

INSTALLATIONSANLEITUNG

mei

DE

INSTALLATION

Installationsvorbereitung

- ◆ Schalten Sie die gesamte Stromversorgung des Vendingautomaten AUS.

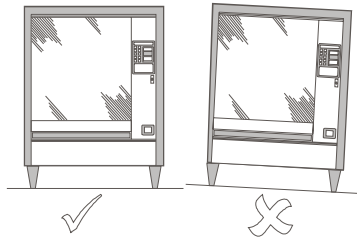

- ◆ Überzeugen Sie sich visuell, dass der Vendingautomat sowohl von der Seite als auch von der Front gesehen senkrecht steht, um seine korrekte Funktion zu gewährleisten.
- ◆ Vergewissern Sie sich vor dem Montieren des Wechslers, dass die Betriebsspannung des Vendingautomaten mit der auf dem Wechsleretikett angegebenen übereinstimmt.

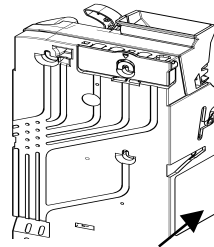

Etikett

Installation des Wechslers im Automaten

Der Wechsler wird am Vendingautomaten angebracht, indem er in drei am Vendingautomaten befindliche Schraubstutzen eingehängt wird. Öffnen Sie dazu den Münzprüfer und richten Sie die Montagelöcher des Wechslers mit den Stutzen am Vendingautomaten aus.

- ◆ Drücken Sie die gelbe Taste oben am Wechsler und ziehen Sie den Münzprüfer vorsichtig nach oben und vorne. Nach dem Öffnen sind die Montagelöcher sichtbar.

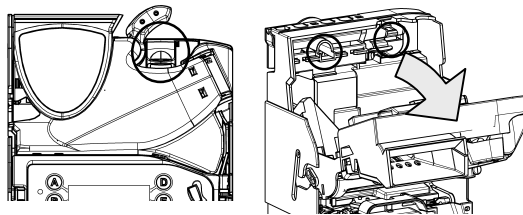

- ◆ Lösen Sie die drei Schraubstutzen am Automaten teilweise, um den Münzwechsler sicher anzubringen.
- ◆ Richten Sie die drei Montagelöcher am Münzwechsler an den Stutzen aus und hängen Sie ihn dann ein. Vergewissern Sie sich, dass der Münzwechsler flach an der Rückwand des Automaten aufliegt.

- ◆ Ziehen Sie alle drei Schraubstutzen fest und bringen Sie den Münzprüfer in seine normale Position.

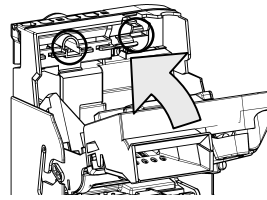
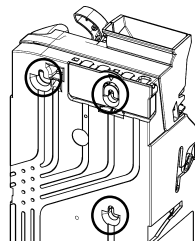

Prüfen der Ausrichtung

Nachdem der Münzwechsler sicher am Vendingautomaten angebracht wurde, prüfen Sie die Funktion des Rückgabehebels und die Ausrichtung des Münzschachts. Tun Sie dies ohne jede Stromzufuhr zum Automaten.

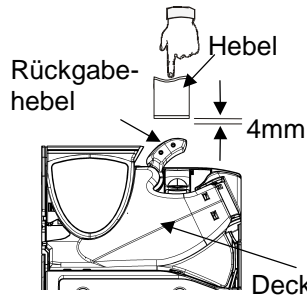

Vergewissern Sie sich, dass ein minimaler Abstand von 4mm zwischen dem Rückgabehebelmechanismus am Automaten und der Rückgabetaaste am Münzwechsler vorhanden ist. Drücken Sie mehrmals den Hebel am Automaten und vergewissern Sie sich, dass der Deckel am Münzprüfer ordnungsgemäß geöffnet und geschlossen wird.

Werfen Sie zwei Münzen von jedem Typ durch den Münzeinwurfschlitz des Automaten ein, um die korrekte Ausrichtung des Münzschachts des Automaten zu prüfen.

Vergewissern Sie sich, dass die eingeworfenen Münzen ungehindert in den Münzwechsler fallen und in die Wechselgeldschale des Automaten ausgegeben werden.

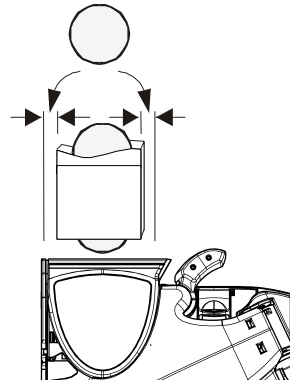

Kabelanschluss

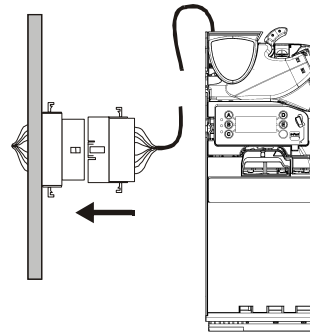

Am Münzwechsler können mehrere Kabel angebracht werden, die jeweils zur TX-RX-Kommunikation, zur Steuerung einer externen Anzeige oder zum Abruf von Audit-Daten verwendet werden können. Nachdem alle relevanten Kabel angeschlossen sind und bevor der Automat geschlossen wird, vergewissern Sie sich, dass alle unbenutzten Kabel sicher verstaut sind und nicht zwischen dem Rückgabehebelmechanismus und der Automatentür eingeklemmt werden. Anschließend können Sie die Stromzufuhr zum Vendingautomaten EINSCHALTEN.

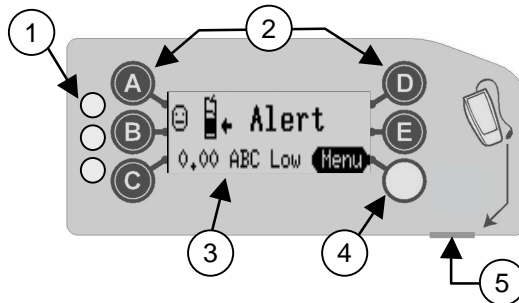

TASTATURFUNKTIONEN

An der Vorderseite des CF7000 Münzwechslers ist eine als Benutzer-Interface dienende Tastatur vorhanden. Es umfasst drei LEDs, sechs Funktionstasten, eine große Menüanzeige und, je nach Münzwechslersmodell, einen Infrarot-Port. Die Tastatur ermöglicht die Münzausgabe aus dem 5-Röhren-Dispenser, den Zugriff auf und das Navigieren durch die Konfigurationsmenüs sowie das Prüfen des Münzwechslersstatus.



1	3 LEDs	Rot, gelb, grün
2	 Zweck 	Münzausgabe & Menünavigation
3	Anzeige (LCD)	Menüinformationen & Warnanzeige
4	 Modustaste	Zugriff auf Service- & Setup-Menüs
5	Serviceanschluss	CPM-kompatibel

Die LEDs geben durch ihr Aufblinken visuell Aufschluss über den Status des Münzwechslers. Eine LED kann AN oder AUS sein oder BLINKEN. Die Blinkcodes zeigen an, ob der Münzwechslers ordnungsgemäß arbeitet, sich im Konfigurations-/Programmiermodus befindet, oder ob ein Fehler vorliegt. (Weitere diesbezügliche Details finden Sie im Abschnitt LED-Codes.)

Die blauen Tasten (als A bis E markiert) haben zwei Funktionen. Wenn der Münzwechslers betriebsbereit ist, wird durch Drücken einer einzelnen blauen Taste eine Münze aus der entsprechenden Röhre ausgezahlt. Durch das ca. 4 Sekunden lange Drücken der blauen Taste wird die automatische Auszahlung aktiviert, bis keine Münzen in der Röhre verbleiben. Wenn jedoch die gelbe Taste (Modus) gedrückt wird, dienen die blauen Tasten zum Navigieren durch die **Service-** und **Setup-**Menüs des Münzwechslers. (Siehe Abschnitt Menüstruktur)

Service-Modus: Gibt Zugriff auf die am häufigsten verwendeten Produktkonfigurationsoptionen. (Siehe Service-Modus-Optionen)

Setup-Modus: Gibt Zugriff auf die allgemeinen Produktkonfigurationsoptionen, die zum Einrichten des Münzwechslers benötigt werden. (Siehe Setup-Modus-Optionen)

VORBEREITUNG

Der Münzwechsler führt nach dem erstmaligen Einschalten einen Selbsttest aus, wobei der Münzwechslermotor hörbar ist, die LEDs fünfmal die Sequenz rot, gelb und grün durchlaufen und kurzfristig die Softwareversion angezeigt wird.

Da sich keine Münzen in der Röhrenkassette befinden, enthält die Anzeige eine Warnmeldung über den niedrigen Füllstand der Röhren, um zum Auffüllen der Münzröhren auf einen vorbestimmten Füllstand aufzufordern (siehe Abschnitt Füllen der Münzröhren). Wenn sich eine ausreichende Anzahl von Münzen in den Röhren des Münzwechslers befindet, erscheinen die in den Röhren enthaltenen Gesamtmünzwerte (in der Landeswährung) in der Anzeige.

Hinweis: MEI empfiehlt, vor dem Verlassen des Automaten eine geringe Zahl von Münzen (z. B. 5 jeder Art) in jede Röhre einzugeben.

Füllen der Münzröhren

Die Röhren des Münzwechslers können auf zwei Arten gefüllt werden. Jede Röhre kann 1) manuell gefüllt werden, indem Münzen in die Röhren eingegeben werden, oder 2) durch den Zugriff auf den Service-Modus, die Auswahl von "Füllen" und den anschließenden Einwurf jeder Münze in den Münzprüfer.

Manuelles Füllen der Röhren

1. Entfernen Sie die Röhrenkassette aus dem Münzwechsler
2. Geben Sie die erforderliche Zahl Münzen in die jeweiligen Röhren ein
3. Bringen Sie die Röhrenkassette wieder am Münzwechsler an.

Der Münzwechsler führt anschließend eine automatische Messung und Kalibrierung der Röhren durch. Das dabei vernehmbare Klickgeräusch ist normal. Nachdem die Kalibrierung beendet ist, erscheint der Gesamtwert der eingegebenen Münzen auf der Anzeige. Wenn die Röhre leer gelassen wird, erscheint eine Warnmeldung über den niedrigen Füllstand der entsprechenden Röhre auf der Anzeige.

Füllen der Röhren über das Service-Modus-Menü

1. Drücken Sie einmal die gelbe Modus-Taste
2. Drücken Sie Taste A und werfen Sie Münzen in den Münzprüfer ein
3. Die Anzeige gibt Aufschluss über die für jede Röhre erforderliche Zahl von Münzen (der angezeigte Zählwert nimmt mit jeder eingeworfenen Münze ab)
4. Drücken Sie Taste A, um den Füllmodus zu beenden.

Menüstruktur des Münzwechslers

Service-Modus

Der Zugriff auf die Setup-Menüs kann auf eine von zwei Arten erfolgen.

1. Halten Sie die Modus-Taste 2 Sekunden lang gedrückt.
2. Drücken Sie einmal kurz die Modus-Taste und wählen Sie dann die Setup-Option durch Drücken von Taste E. (Diese Methode erfordert die Eingabe eines Passcodes. Drücken Sie die Tasten ABC, wenn Sie zu seiner Eingabe aufgefordert werden.)

Taste D durchläuft die Menüs nach OBEN



Taste E durchläuft die Menüs nach UNTEN

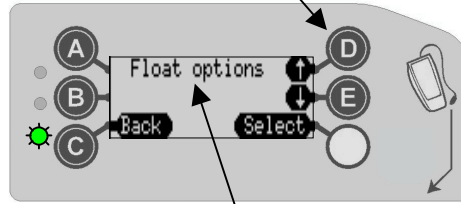

Gewählte Menüoption

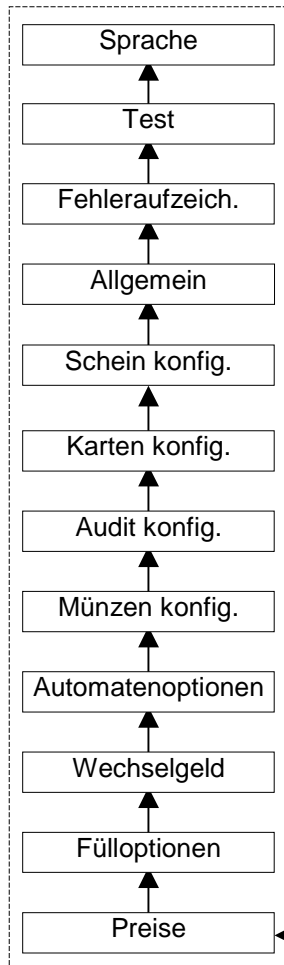































Menü beginnt hier

BEISPIEL: Sprache einstellen







1. Modus-Taste 1 x drücken
2. **Einstell.** mit Taste **E** wählen
3. Passcode eingeben, **ABC** drücken
4. Menü mit Taste **D** nach oben durchlaufen bis **Sprache** angezeigt wird
5. **Wählen**, dann **Bearbeiten** drücken
6. Gewünschte Sprache mit Taste **D** oder **E** suchen
7. **OK** wählen
8. **Zurück** wählen, dann nochmals **Zurück** zum Speichern der Einstellung und Beenden des Menüs

Service-Modus-Optionen (Kurzmenü-Codes)

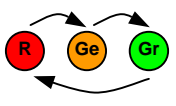
Die folgende Liste zeigt die am häufigsten verwendeten Service-Modi.





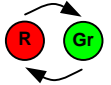

Folgende Tastensequenz drücken	Beschreibung / Vorgang
 	Münzröhren füllen (Münzen eingeben, dann Modus-Taste drücken)
  	Angesammelten Kredit löschen, dann Meldung "Münzprüfer reinigen" löschen. Diese Funktion ist an MDB-Produkten nicht verfügbar.
  	Füllhöhe lernen stellt die Füllhöhen auf die gegenwärtigen Füllstände der Münzröhren ein.
 	Münze sperren (Eine Münze eingeben, dann Rückgabehebel drücken)
 	Münze freigeben (Eine Münze eingeben, dann Modus-Taste drücken)
  	Münzdetails anzeigen ( zum Durchlauf nach oben drücken) ( zum Durchlauf nach unten drücken)
  	Kanalsatz anzeigen ( zum Beenden der Anzeige drücken)
 	Verkaufspreis lernen (Münzen bis zum Wert des Preises eingeben, dann Verkaufsart-Taste am Automaten zum Einstellen drücken) ( drücken, wenn der Vorgang beendet ist) Diese Funktion ist an Exec-Produkten nicht verfügbar.
 	Kundenspezifische Röhrenkassette lernen / (Code eingeben und  drücken)
   	Vordefinierte Röhrenkassette lernen / (dann Rückgabehebel drücken)

Allgemeine LED-Codes

	An - Münzwechsler in Ordnung.
	5 Zyklen - Normale Einschaltsequenz. Münzprüfer in Ordnung.
	Blinkt / Aus - Münze angenommen / zurückgewiesen.
	Blinkt - Münzwechsler im Menü-Modus
	An - Münzwechsler von VMC gesperrt.
	Blinkt - Münzwechsler erfordert Aufmerksamkeit. (Siehe gelbe LED-Codes)
	Aus - Kein Strom am Münzwechsler. (Anschluss der Stromkabel prüfen & sicherstellen, dass die Stromzufuhr AN ist)
	Abwechselnd - Fehler am Münzwechsler (Aus dem Vendingautomaten entfernen)

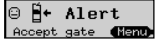
Gelbe LED-Codes

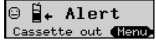
Das Blinken der gelben LED verweist auf einen Fehler an einem der Hauptmodule des Münzwechslers. Diese Fehlerarten können am Automaten behoben werden. Sie haben z. B. folgende Ursachen: Münzstau, Schmutzablagerung, Kassette entnommen usw. Der Münzprüfer gibt in der Anzeige ebenfalls das betroffene Modul an.

Blinken	zu prüfender Münzprüfer	
1 x 	Münzprüfer	
2 x 	Annahmetor	
3 x 	Separatoreinheit	
4 x 	Auszahleinheit	

Auswählen von vordefinierten Kassetten

Im Speicher des Münzprüfers ist eine Anzahl vordefinierter Röhrenkassetten mit unterschiedlichen Auszahlungsoptionen gespeichert. (Siehe Tabelle unten)

Die gewünschte Auszahlungsoption kann durch Drücken der entsprechenden Tasten der Tastatur gewählt werden.

Die korrekte Tastenfolge ist ebenfalls auf dem vorne an der Kassette angebrachten Etikett angegeben.

Drücken Sie zur Auswahl einer vordefinierten Kassette die Modus-Taste, dann D gefolgt vom Tastencode.

Wählen Sie 'Annehmen' aus dem Menü, um die Einstellungen zu bestätigen und zu speichern.

Tastencode	Röhre A	Röhre B	Röhre C	Röhre D	Röhre E
AA	5c	10c	50c	20c	5c
AB	1c	10c	50c	2c	5c
AC	5c	10c	50c	20c	1€uro
AD	5c	10c	50c	10c	1€uro
AE	5c	10c	50c	10c	5c
BA	10c	10c	50c	10c	1€uro
BB	10c	10c	50c	20c	1€uro
BC	20c	10c	50c	1€uro	2€uro
BD	1€uro	-	50c	1€uro	2€uro
BE	1€uro	-	50c	2€uro	2€uro
CA	1c	10c	50c	1€uro	5c

SICHERHEIT

Einhaltung nationaler und internationaler Normen

Produkte der Serie CashFlow[®] 7000 arbeiten mit einer extra niedrigen Sicherheitsspannung (SELV), wie in IEC335/EN60335 'Sicherheit von Haushaltsgeräten und ähnlichen Geräten' definiert. Sie können in Geräten integriert werden, die IEC335/EN60335 oder IEC950/EN60950 'Sicherheit von IT-Geräten' entsprechen.

Produkte der Serie CashFlow[®] 7000 gehören zur Klasse 3.

Nennbetriebsspannung

Die Betriebsspannung eines Wechslers der Serie CashFlow[®] 7000 ist auf dem am Produkt angebrachten Etikett angegeben. Er darf nur mit der angegebenen Stromquelle eingesetzt werden.

Gefährliche Umfelder

Der Wechsler der Serie CashFlow[®] 7000 darf nicht beim Vorhandensein von brennbaren Gasen, Dämpfen oder Wasser eingesetzt werden.

Produktentsorgung

Kein Teil eines Wechslers der Serie CashFlow[®] 7000 sollte durch Verbrennen entsorgt werden.

CashFlow[®] 7000-Münzprüferserie Installationshandbuch

Revision G1

Veröffentlichungsdatum: November 2003

Herausgegeben von:
MEI
Eskdale Road
Winnersh Triangle
Wokingham, Berkshire
RG41 5AQ
United Kingdom



Internet: <http://www.meiglobal.com>

Eine Kopie des Handbuchs für Kundendiensttechniker ist auf schriftliche Anfrage an die obige Adresse vom Manager des technischen Diensts erhältlich.

Mars[®], CashFlow[®] und das MEI Emblem sind eingetragene Warenzeichen. Copyright Mars Inc 2003.

**Monedero de cambio
CASHFLOW™ serie 7000**

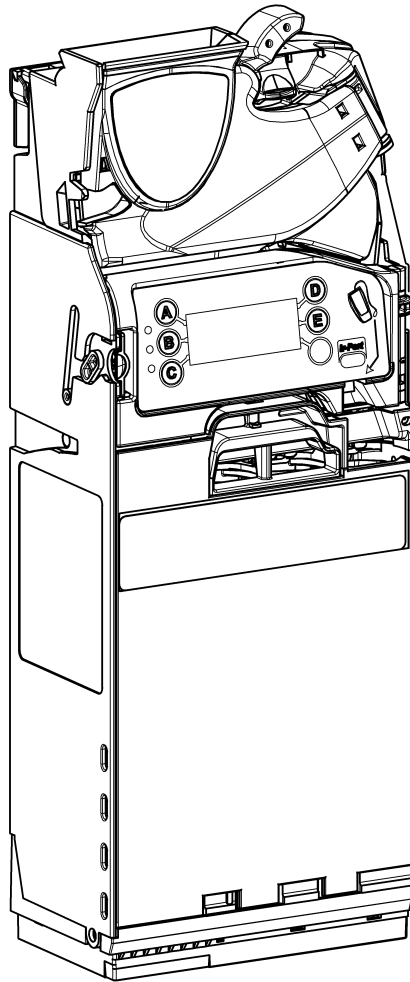

GUÍA DE INICIO



ES

INSTALACIÓN

Preparación de la instalación

- ◆ Apague completamente la máquina expendedora.

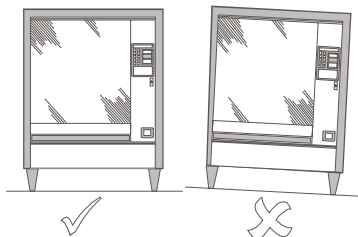

- ◆ Para asegurarse de que no se vea afectado el funcionamiento del monedero de cambio, compruebe visualmente que la máquina expendedora está derecha observándola tanto frontal como lateralmente.
- ◆ Antes de montar el monedero de cambio en la máquina expendedora, compruebe que la tensión que suministra la máquina expendedora coincide con la indicada en la etiqueta del monedero de cambio.

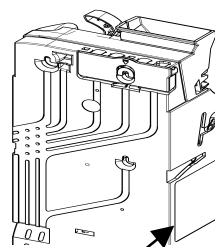

Etiqueta

Instalación del monedero de cambio en la máquina

El monedero de cambio se monta en la máquina expendedora colgándolo de los tres salientes ubicados en la máquina expendedora. Para ello, deberá bajar el módulo discriminador y alinear los orificios de montaje del monedero con los salientes de la máquina expendedora.

- ◆ Pulse la tecla amarilla situada en la parte superior del monedero y levante y tire suavemente en dirección recta del módulo discriminador. Una vez abierto, los orificios de montaje quedarán visibles.

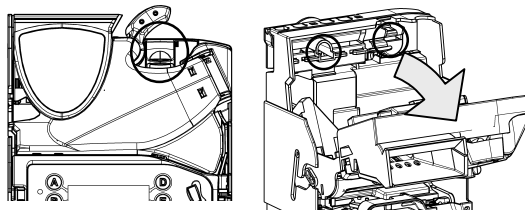

- ◆ Para ajustar de forma segura el monedero de cambio, desatornille parcialmente los tres salientes de la máquina.
- ◆ Alinee los tres orificios de montaje del monedero de cambio con los salientes y cuélguelo asegurándose de que el monedero de cambio reposa totalmente pegado a la plancha posterior de la máquina.

- ◆ Apriete los tres salientes y vuelva a colocar el discriminador en su posición habitual.

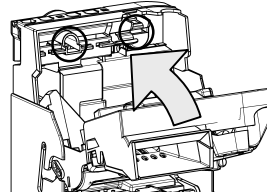
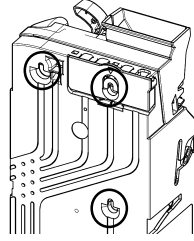

Comprobaciones de la alineación

Una vez que el monedero de cambio esté correctamente ajustado a la máquina expendedora, compruebe el funcionamiento de la palanca de devolución y la alineación del canal de entrada de monedas. Hágalo sin aplicar ninguna alimentación eléctrica a la máquina.

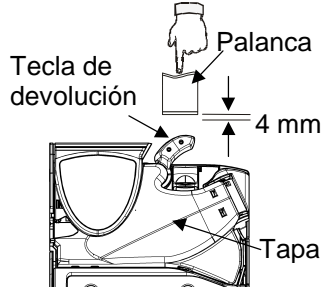

Compruebe que haya un hueco de 4 mm como mínimo entre el mecanismo de palanca de devolución de la máquina y la tecla de devolución del monedero de cambio. Pulse la palanca de devolución un par de veces y asegúrese de que la tapa del discriminador se abre y se cierra correctamente.

Compruebe la alineación del canal de entrada de monedas introduciendo dos monedas de cada valor a través de la ranura de entrada de monedas de la máquina. Asegúrese de que las monedas caen libremente en el monedero de cambio y salen a la cubeta de devolución de la máquina.

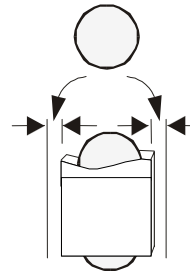

Conexión de cable(s)

El monedero de cambio puede contar con más de un cable, por ejemplo, para comunicaciones TX-RX, para display de crédito o para extraer datos de contabilidad.

Una vez que se hayan conectado todos los cables necesarios y antes de cerrar la puerta de la máquina, recoja la parte sobrante de los cables de forma ordenada para asegurarse de que no quedan atrapados entre el mecanismo de la palanca de devolución y la puerta de la máquina expendedora. Ahora puede activar la alimentación de la máquina expendedora

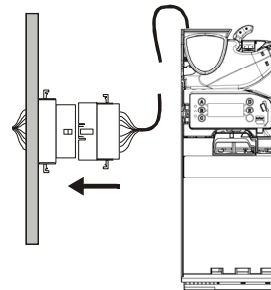
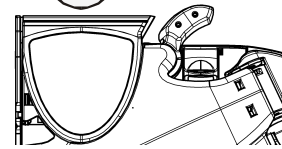



FUNCIONES DEL TECLADO

En la parte frontal del monedero de cambio CashFlow® 7000 hay un teclado de interfaz de usuario. El teclado cuenta con tres LED, seis botones de función, una pantalla de menús grande y, dependiendo del modelo del monedero de cambio, un puerto de infrarrojos.

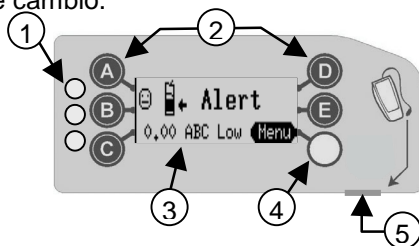
Este teclado le permite dispensar monedas del dispensador de cinco tubos, acceder a los menús de configuración y desplazarse por ellos y comprobar el estado del monedero de cambio.

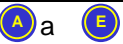

1	3 LED	Rojo, ámbar, verde
2		Dispensar monedas y desplazarse por los menús
3	Pantalla (LCD)	Pantalla de información de menús y advertencia
4	 Tecla de modo	Acceder a menús de servicio y configuración
5	Conector de servicio	Compatible con CPM

Los LED proporcionan una indicación visual mediante parpadeos de luz que informan del estado del monedero de cambio. Un LED puede estar encendido, apagado o parpadeando. Estos códigos de parpadeo de luz indican cuándo el monedero de cambio está funcionando con normalidad, cuándo está en modo de configuración/programación o cuándo presenta un fallo. (Consulte la sección de códigos de luz de LED para obtener más información).

Las teclas azules (etiquetas de A a E) tienen dos funciones.

Cuando el monedero de cambio está en modo de reposo, al pulsar un tecla azul por sí solo se dispensa una moneda del tubo correspondiente. Al mantener pulsado la tecla azul durante aproximadamente 4 segundos, se activa la dispensación automática (dispensación continua de monedas) hasta que el tubo queda vacío. No obstante, si se pulsa la tecla amarilla (modo), los botones azules sirven para desplazarse por los menús de **servicio** y de **modo de configuración** del monedero de cambio. (Consulte la sección sobre la estructura de los menús).

Modo de servicio: proporciona acceso a las opciones de configuración del producto utilizadas con mayor frecuencia. (Consulte Opciones del modo de servicio)

Modo de configuración: proporciona acceso a las opciones de configuración general del producto que son necesarias al configurar el monedero de cambio. (Consulte Opciones del modo de configuración)

INICIO

Al encenderse por primera vez, el monedero de cambio realiza una autocomprobación que provoca que suene el motor del monedero de cambio, que los LED se enciendan cinco veces siguiendo la secuencia rojo, ámbar y verde, y que se muestre brevemente la versión del software.

Dado que no hay monedas en el cartucho de tubos, la pantalla mostrará un mensaje que avisa de que los tubos están a bajo nivel y que solicita la reposición de monedas en los tubos hasta alcanzar un nivel predefinido (consulte la sección sobre carga de los tubos de monedas). Una vez que el monedero de cambio disponga de suficientes monedas en los tubos, el mensaje mostrará los totales de monedas (en el valor de la divisa) almacenadas en los tubos.

Nota: MEI recomienda la inserción de una pequeña cantidad de monedas (por ejemplo, 5 de cada tipo) en cada tubo antes de abandonar la máquina.

Carga de los tubos de monedas

Existen dos formas de cargar monedas en los tubos del monedero de cambio. Puede: 1) llenar manualmente cada tubo introduciendo monedas en los tubos o 2) acceder al modo de servicio y seleccionar "Carga" y, seguidamente, introducir cada moneda a través del discriminador.

Carga manual de los tubos

1. Extraiga el cartucho de tubos del monedero de cambio
2. Introduzca el número de monedas requerido en los tubos de almacenamiento correspondientes
3. Vuelva a colocar el cartucho de tubos en el monedero de cambio.

El monedero de cambio comenzará una medición automática de calibración de tubos que provocará que se oigan varios "clics". Este ruido es normal. Una vez terminada la calibración, la pantalla mostrará el valor total de las monedas introducidas. Si se deja vacío un tubo, la pantalla mostrará un mensaje que indica que el tubo en cuestión se encuentra a bajo nivel.

Llenado de tubos mediante el menú de modo de servicio

1. Pulse una vez la tecla de modo amarilla
2. Pulse la tecla A y comience a introducir monedas a través del discriminador
3. La pantalla mostrará el número de monedas necesarias para cada tubo.
(Cada vez que se introduzca una moneda, el recuento mostrado se reducirá en una unidad.)
4. Pulse la tecla A para salir del modo de carga

Estructura de menús del monedero de cambio

Modo de servicio

Existen dos formas de acceder a los menús de configuración.

1. Pulse y mantenga pulsado la tecla de modo durante 2 segundos
2. Pulse la tecla de modo una vez y seleccione la opción "Configurar" pulsando la tecla E. (Este método exige un código de entrada. Cuando se le solicite, pulse los botones ABC)

Pulse D: desplaza los menús hacia arriba



Pulse E: desplaza los menús hacia abajo

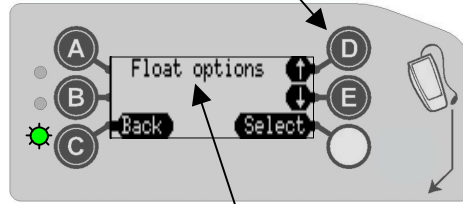

Opción de menú seleccionada

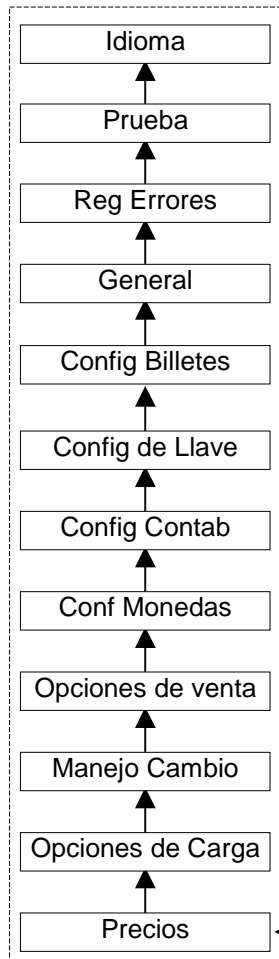































El menú comienza aquí

EJEMPLO: - Configuración del idioma







1. Pulse una vez la tecla de modo
2. Pulse **E** para elegir **Configurar**
3. Introduzca el código de entrada, pulse **ABC**
4. Pulse la tecla **D** para ir hacia arriba por el menú hasta que vea **Idioma**
5. Pulse **Seleccionar** y luego **Editar**
6. Use **D** o **E** para desplazarse al idioma deseado
7. Seleccione **OK**
8. Seleccione **Atrás** y **Atrás** de nuevo para guardar y salir

Opciones del modo de servicio (códigos rápidos de menús)

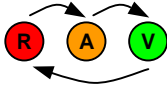
Esta lista muestra los modos de servicio utilizados con mayor frecuencia.





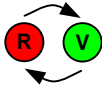



Pulse la siguiente secuencia de botones	Descripción / acción
 	Carga de tubos de monedas / (Introduzca monedas y luego pulse la tecla de modo)
  	Borra el crédito acumulado y el mensaje "Límpieme". Esta función no está disponible en productos MDB.
  	Enseñar carga modifica los niveles de carga.
 	Inhibir una moneda / (Introduzca una moneda y luego pulse la palanca de devolución)
 	Activar una moneda / (Introduzca una moneda y luego pulse la tecla de modo)
  	Ver detalles de moneda / (pulse  para desplazarse hacia arriba) (pulse  para desplazarse hacia abajo)
  	Versión de programa de monedas / pulse  para salir
 	Enseñar precio de venta / (Introduzca monedas hasta alcanzar el valor del precio y luego pulse la selección asociada en la máquina para establecerlo) (Cuando termine, pulse la tecla ) Esta función sólo está disponible en productos Executive.
 	Enseñar cartucho de tubos personalizado / (Introduzca el código y pulse )
   	Seleccionar cartucho de tubos predefinido / (luego pulse la palanca de devolución)

Códigos LED generales

	Encendido – el monedero de cambio funciona correctamente.
	5 ciclos – secuencia normal de encendido. El monedero de cambio funciona correctamente.
	Parpadea una vez – moneda aceptada/devuelta.
	Parpadeando – monedero de cambio en programación.
	Encendido – monedero de cambio inhibido por máquina.
	Parpadeando – el monedero de cambio requiere mantenimiento. (Consulte los códigos de LED ámbar)
	Apagado – el monedero de cambio no recibe alimentación. (Compruebe la conexión de los cables y la alimentación desde la máquina)
	Alternando – el monedero de cambio tiene una avería (Retírelo de la máquina expendedora)

Códigos de LED ámbar

Si parpadea el LED ámbar, ello indica que se ha detectado un fallo en uno de los módulos principales del monedero de cambio. La mayoría pueden corregirse en la máquina y pueden estar provocados, por ejemplo, por un atasco de monedas, la acumulación de suciedad, la extracción del cartucho, etc. El monedero de cambio también indicará en pantalla el módulo afectado.

Parpadeos	Compruebe el siguiente módulo del monedero de cambio
1 	Discriminador 
2 	Puerta de aceptación 
3 	Módulo de separador 
4 	Módulo de dispensador 

Selección de un cartucho predefinido

El monedero de cambio tiene almacenada en la memoria una serie de cartuchos de tubos predefinidos que proporcionan diferentes opciones de cambio. (Consulte la siguiente tabla.)

Pulsando los códigos de botones correctos en el teclado, puede seleccionar la opción de cambio deseada.

El código correcto de secuencia de botones también se encuentra en la etiqueta delantera del cartucho.

Para seleccionar un cartucho predefinido, pulse la tecla de modo y luego D seguido del código de tecla.

Finalmente, seleccione aceptar del menú para confirmar y guardar.

Código de tecla	Tubo A	Tubo B	Tubo C	Tubo D	Tubo E
AA	5 c	10 c	50 c	20 c	5 c
AB	1 c	10 c	50 c	2 c	5 c
AC	5 c	10 c	50 c	20 c	1 €uro
AD	5 c	10 c	50 c	10 c	1 €uro
AE	5 c	10 c	50 c	10 c	5 c
BA	10 c	10 c	50 c	10 c	1 €uro
BB	10 c	10 c	50 c	20 c	1 €uro
BC	20 c	10 c	50 c	1 €uro	2 €uro
BD	1 €uro	-	50 c	1 €uro	2 €uro
BE	1 €uro	-	50 c	2 €uro	2 €uro
CA	1 c	10 c	50 c	1 €uro	5 c

SEGURIDAD

Cumplimiento de normas nacionales e internacionales

Los productos CashFlow® serie 7000 funcionan con un nivel de tensión de seguridad extra bajo (SELV) conforme a lo establecido en IEC335/EN60335 'Safety of Household and Similar Appliances' (seguridad de aparatos domésticos y similares). Pueden instalarse en equipos que cumplan la norma IEC335/EN60335 o IEC950/EN60950 'Safety of Information Technology Equipment' (seguridad de equipos de tecnología de la información). Los productos CashFlow® serie 7000 tienen un diseño de Clase 3.

Tensión nominal de funcionamiento

La tensión de funcionamiento del monedero de cambio CashFlow® serie 7000 se indica en la etiqueta que se encuentra adherida al producto. No debe utilizarse con fuentes de alimentación distintas de la indicada.

Entornos peligrosos

El monedero de cambio CashFlow® serie 7000 no debe utilizarse en presencia de gases inflamables, humo o agua.

Eliminación del producto

Absténgase de incinerar parte alguna del monedero de cambio CashFlow® serie 7000.

Guía de inicio para el monedero de cambio CashFlow® serie 7000

Revisión G1

Fecha de publicación: Noviembre de 2003

Publicado por:

MEI

Eskdale Road

Winnersh Triangle

Wokingham, Berkshire

RG41 5AQ

Reino Unido



Internet: <http://www.meiglobal.com>

Para obtener una copia del manual para ingenieros (Engineers Handbook), escriba al Jefe del servicio técnico (Technical Service Manager) a la dirección anterior.

Mars®, CashFlow® y el logotipo de MEI son marcas registradas.
Copyright Mars Inc 2003.

**Rendiresto serie
CASHFLOW™ 7000**

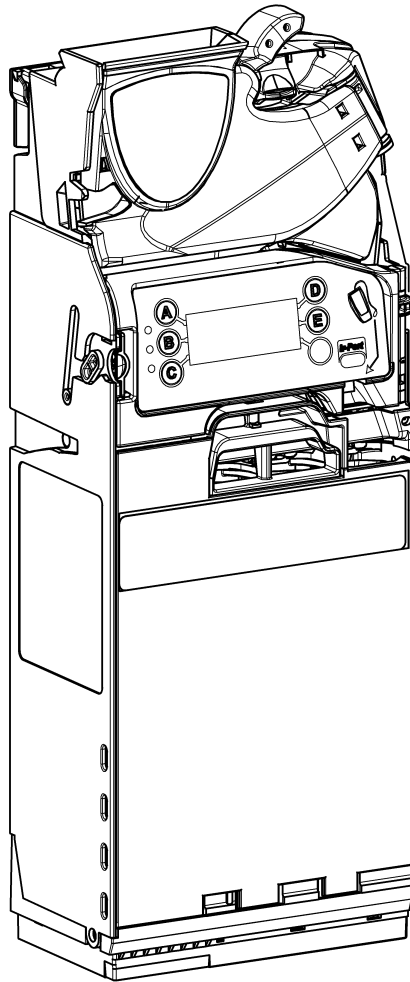

GUIDA INTRODUTTIVA

mei

IT

INSTALLAZIONE

Preparazione all'installazione

- ◆ Disattivare l'alimentazione del distributore automatico.

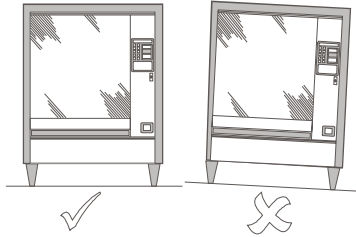

- ◆ Per garantire il funzionamento ottimale della rendiresto, verificare che il distributore automatico sia in posizione perfettamente verticale.
- ◆ Prima di installare la rendiresto sul distributore automatico, controllare che la tensione di alimentazione del distributore corrisponda a quella indicata sull'etichetta della rendiresto.

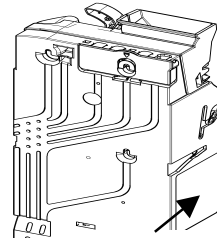

Etichetta

Installazione della rendiresto sul distributore automatico

La rendiresto viene fissata al distributore automatico per mezzo di tre borchie presenti all'interno del distributore. Per farlo, è necessario aprire il discriminatore e allineare i fori di montaggio della rendiresto alle borchie del distributore automatico.

- ◆ Premere il pulsante giallo posto sulla parte superiore della rendiresto, quindi tirare leggermente il discriminatore per aprirlo. A questo punto, i fori di montaggio saranno visibili.

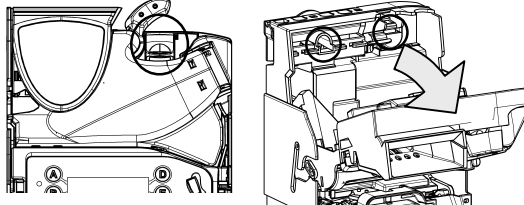

- ◆ Per fissare correttamente la rendiresto, allentare leggermente le tre borchie del distributore.
- ◆ Allineare i tre fori di montaggio della rendiresto alle borchie, quindi agganciare la rendiresto al distributore automatico, facendola aderire perfettamente alla piastra di sostegno.

- ◆ serrare le borchie e riportare il discriminatore nella posizione originaria.

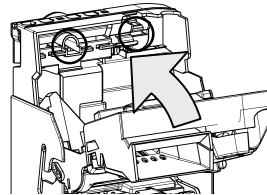
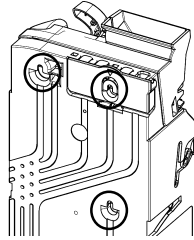

Verifica degli allineamenti

Dopo avere installato la rendiresto, verificare il corretto funzionamento della leva di recupero e l'allineamento della guida monete, senza riattivare l'alimentazione del distributore automatico.

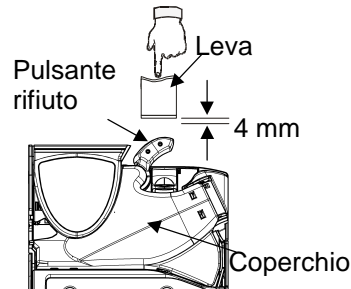

Verificare che tra la leva di recupero e il pulsante di rifiuto del distributore vi sia uno spazio di almeno 4 mm. Premere un paio di volte la leva e verificare che il coperchio del discriminatore si apra e si chiuda correttamente.

Inserire due monete di ogni formato nella fessura di ingresso monete per verificare il corretto allineamento della guida. Assicurarsi che le monete cadano correttamente nella rendiresto e fuoriescano nella vasca di raccolta delle monete restituite.

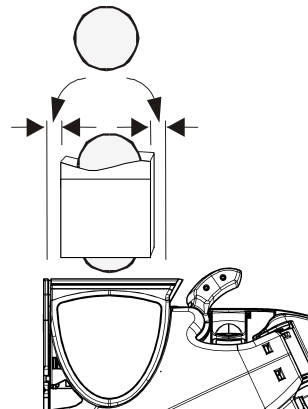

Collegamento dei cavi

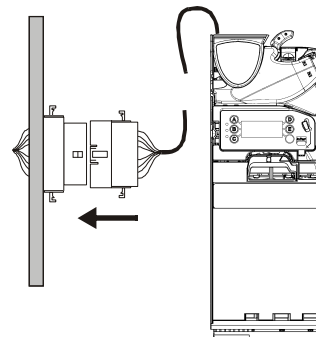

È possibile che la rendiresto sia provvista di più cavi destinati a comunicazioni TX-RX, al collegamento di un display esterno o all'estrazione di dati di controllo. Una volta collegati tutti i cavi necessari, prima di chiudere lo sportello del distributore, riporre ordinatamente all'interno eventuali cavi inutilizzati, in modo che non rimangano incastrati tra il meccanismo della leva di recupero e lo sportello del distributore. Riattivare l'alimentazione del distributore automatico.

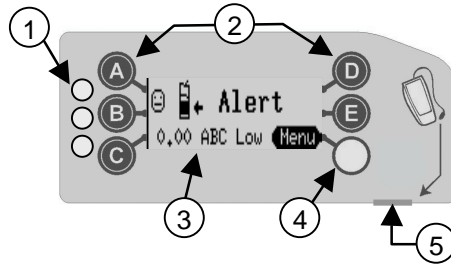

FUNZIONI DELLA TASTIERA

La rendiresto CashFlow® 7000 è provvista di una tastiera di interfaccia utente posta sul lato anteriore. La tastiera presenta tre LED, sei pulsanti funzione, un display di grandi dimensioni e, a seconda del modello, una porta a infrarossi. Tramite la tastiera è possibile controllare l'erogatore monete a cinque tubi, visualizzare e selezionare le opzioni dei menu di configurazione e monitorare lo stato della rendiresto.



1	3 LED	Rosso, ambra e verde
2	 A - E	Erogazione monete e navigazione tra i menu
3	Display (LCD)	Informazioni sui menu e messaggi di errore
4	 Pulsante giallo	Accesso ai menu di servizio e configurazione
5	Connettore di servizio	Compatibile con CPM

I LED forniscono un'indicazione visiva dello stato della rendiresto. Ogni LED può essere acceso, spento oppure lampeggiante. Tali codici luminosi indicano se la rendiresto funziona correttamente, si trova in modalità di configurazione/programmazione o se è guasta (per ulteriori informazioni, vedere la sezione dedicata ai LED).

I pulsanti blu (contrassegnati dalle lettere A - E) hanno due funzioni. Se la rendiresto è in modalità non operativa, quando si preme uno dei pulsanti blu viene erogata una moneta dal tubo corrispondente. Se il pulsante viene tenuto premuto per circa 4 secondi, viene attivata l'erogazione automatica di tutte le monete, fino al completo svuotamento del tubo. Se invece è stato premuto il pulsante giallo (Modo), i pulsanti blu consentono di navigare all'interno dei menu di **servizio** e **configurazione** (vedere la sezione relativa alla struttura dei menu).
Modalità di servizio: consente di accedere alle opzioni di configurazione del prodotto più utilizzate (vedere Opzioni della modalità di servizio).
Modalità di configurazione: consente di accedere a opzioni di configurazione generiche, utilizzate durante l'impostazione della rendiresto (vedere Opzioni della modalità di configurazione).

AVVIO

Alla prima accensione, la rendiresto esegue un test di autodiagnostica, durante il quale il motore emette un segnale acustico, i LED si illuminano cinque volte nella sequenza rosso, ambra e verde e sul display viene momentaneamente visualizzata la versione corrente del software.

Poiché non vi sono monete nella cassetta tubi, sul display viene visualizzato un messaggio di avviso in cui si richiede il riempimento dei tubi fino al livello predefinito (vedere la sezione relativa al riempimento dei tubi monete). Una volta raggiunto il livello di riempimento richiesto, verrà visualizzato l'importo totale delle monete presenti nei tubi.

Nota: MEI raccomanda di inserire una piccola quantità di monete (5 di ogni formato) in ciascun tubo prima di lasciare il distributore.

Riempimento dei tubi monete

I tubi monete della rendiresto possono essere riempiti in due diversi modi. È possibile: 1) inserire manualmente le monete in ciascun tubo, oppure 2) accedere alla modalità di servizio e selezionare "Livello", quindi inserire le monete dal discriminatore.

Riempimento manuale dei tubi

1. Rimuovere la cassetta tubi dalla rendiresto.
2. Inserire la quantità di monete richiesta nei relativi tubi.
3. Reinstallare la cassetta tubi nella rendiresto.

A questo punto, la rendiresto avvia automaticamente una procedura di calibrazione dei tubi, durante la quale vengono emessi dei clic. Si tratta di suoni del tutto normali. Al termine della calibrazione, sul display viene visualizzato l'importo totale delle monete inserite. Se in uno dei tubi non vengono inserite monete, sul display viene visualizzato un messaggio di avviso.

Riempimento dei tubi tramite il menu della modalità di servizio

1. Premere una volta il pulsante giallo Modo.
2. Premere il pulsante A e iniziare a inserire monete dal discriminatore.
3. Sul display viene visualizzato il numero di monete che è necessario inserire in ciascun tubo (a ogni moneta inserita, il numero visualizzato diminuisce di un'unità).
4. Premere il pulsante A per uscire dalla modalità di riempimento.

Struttura dei menu della rendiresto

Modalità di servizio

Per accedere ai menu di configurazione, è possibile procedere in due diversi modi.

1. Premere e mantenere premuto per due secondi il pulsante giallo.
2. Premere una sola volta il pulsante giallo, quindi premere il pulsante E per selezionare l'opzione "Setup". (Questa procedura richiede un codice di accesso. Nel momento in cui viene richiesto, premere i pulsanti ABC.)

Premere D per fare scorrere i menu verso l'alto



Premere E per fare scorrere i menu verso il basso

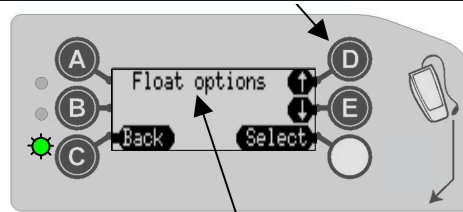

Opzione di menu selezionata

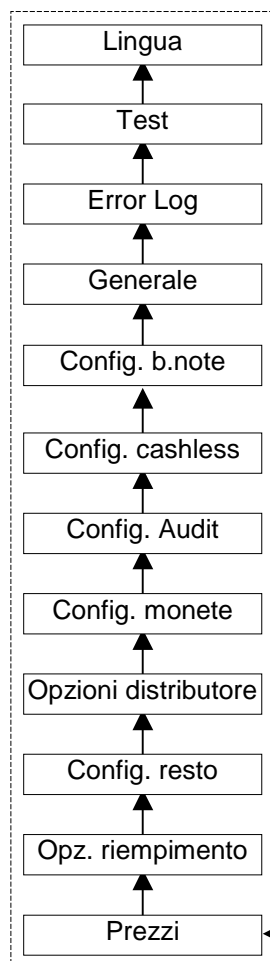

Il menu inizia qui

ESEMPIO: impostazione della lingua







1. Premere una volta il pulsante giallo.
2. Premere il pulsante **E** per selezionare l'opzione **Setup**.
3. Inserire il codice di accesso, premere **ABC**.
4. Premere il pulsante **D** per fare scorrere il menu verso l'alto fino a visualizzare l'opzione **Lingua** sul display.
5. Premere **Selezionare**, quindi **Modifica**.
6. Utilizzare i pulsanti **D** o **E** per selezionare la lingua desiderata.
7. Selezionare **OK**.
8. Selezionare **Indietro** due volte per salvare le impostazioni e uscire.

Opzioni del menu di servizio (codici menu rapido)

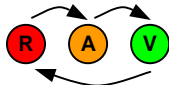
Nella tabella seguente sono riportate le opzioni più utilizzate del menu di servizio.

Sequenza pulsanti	Descrizione / Azione
 	Riempimento tubi monete (inserire le monete e premere il pulsante giallo).
  	Cancellazione credito accumulato e annullamento messaggio di richiesta pulizia. Funzione non disponibile sui prodotti MDB.
  	Riempimento livelli delle serie programmabili in base ai livelli correnti dei tubi monete.
 	Inibizione moneta (inserire una moneta e premere la leva di recupero).
 	Abilitazione moneta (inserire una moneta e premere il pulsante giallo).
  	Visualizzazione dettagli moneta (premere  per scorrere verso l'alto); (premere  per scorrere verso il basso).
  	Visualizzazione channel set (premere  per uscire)
 	Impostazione prezzo (inserire monete fino all'importo desiderato, quindi premere il pulsante della linea prezzo per impostarlo). (Al termine, premere ). Funzione disponibile solo su prodotti Executive.
 	Impostazione cassetta tubi personalizzata (inserire monete e premere ).
   	Selezione cassetta tubi predefinita (inserire il codice riportato sull'etichetta della cassetta e premere il pulsante giallo).

Codici luminosi dei LED

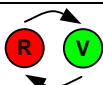
	Acceso: rendiresto OK.
	5 cicli successivi: sequenza di accensione. Rendiresto OK.
	Smette di lampeggiare: moneta accettata / rifiutata.
	Lampeggiante: rendiresto in modalità menu.
	Acceso: rendiresto inibita da VMC.
	Lampeggiante: è stato rilevato un errore. (Vedere codici luminosi LED ambr.)
	Spento: alimentazione rendiresto disattivata. (Verificare che i cavi siano collegati e che l'interruttore dell'alimentazione sia su ON.)
	Alternati: rendiresto guasta (rimuoverla dal distributore automatico).

Codici luminosi del LED ambr

Se il LED ambr lampeggia, significa che è stato rilevato un errore in uno dei moduli principali della rendiresto. In genere, si tratta di errori risolvibili intervenendo sulla macchina e causati da: inceppamenti delle monete, accumulo di sporcizia, rimozione della cassetta, ecc. Sul display della rendiresto è indicato il modulo in cui si è verificato l'errore.

Modalità di lampeggiamento	Modulo da verificare
1 x 	Discriminatore 
2 x 	Porta accettazione 
3 x 	Separatore 
4 x 	Erogatore 

Selezione della cassetta predefinita

Nella memoria della rendiresto sono archiviate una serie di cassette tubi predefinite, ognuna associata a opzioni di pagamento differenti (vedere tabella seguente).

Per selezionare l'opzione di pagamento desiderata, premere il codice pulsanti corrispondente.

Le varie sequenze di pulsanti sono riportate anche sull'etichetta applicata alla parte anteriore della cassetta.

Per selezionare una cassetta predefinita, premere il pulsante giallo, quindi D e il codice pulsanti corrispondente.

Infine, selezionare l'opzione di menu Accetta per confermare e salvare.

Codice pulsanti	Tubo A	Tubo B	Tubo C	Tubo D	Tubo E
AA	5 c	10 c	50 c	20 c	5 c
AB	1 c	10 c	50 c	2 c	5 c
AC	5 c	10 c	50 c	20 c	1 €uro
AD	5 c	10 c	50 c	10 c	1 €uro
AE	5 c	10 c	50 c	10 c	5 c
BA	10 c	10 c	50 c	10 c	1 €uro
BB	10 c	10 c	50 c	20 c	1 €uro
BC	20 c	10 c	50 c	1 €uro	2 €uro
BD	1 €uro	-	50 c	1 €uro	2 €uro
BE	1 €uro	-	50 c	2 €uro	2 €uro
CA	1 c	10 c	50 c	1 €uro	5 c

SICUREZZA

Conformità agli standard nazionali e internazionali

I prodotti della serie CashFlow® 7000 funzionano a livelli di tensione ridotti (SELV), in base a quanto previsto dalla normativa IEC335/EN60335 sulla sicurezza delle apparecchiature domestiche e simili. Questi prodotti possono essere utilizzati con apparecchiature conformi a IEC335/EN60335 o IEC950/EN60950 (sicurezza delle apparecchiature informatiche).
I prodotti della serie CashFlow® 7000 sono di Classe 3.

Tensione nominale di esercizio

La tensione di esercizio della rendiresto CashFlow® 7000 è indicata sull'etichetta applicata al prodotto. Verificare che la corrente di alimentazione utilizzata corrisponda a quella indicata sull'etichetta.

Ambienti pericolosi

Non utilizzare la rendiresto serie CashFlow® 7000 in presenza di gas infiammabili, fumi o acqua.

Smaltimento del prodotto

Non smaltire tramite incenerimento nessun componente della rendiresto serie CashFlow® 7000.

Rendiresto serie CashFlow® 7000 Guida introduttiva
Revisione G1

Data di pubblicazione: Novembre 2003

Pubblicata da:
MEI
Eskdale Road
Winnersh Triangle
Wokingham, Berkshire
RG41 5AQ
Gran Bretagna



Internet: <http://www.meiglobal.com>

Per richiedere una copia del manuale tecnico, contattare un responsabile servizio assistenza clienti all'indirizzo di cui sopra.

Mars®, CashFlow® e il dispositivo MEI sono marchi registrati. Copyright Mars Inc 2003.